



US007295254B2

(12) **United States Patent**
Bendov

(10) **Patent No.:** **US 7,295,254 B2**
(45) **Date of Patent:** **Nov. 13, 2007**

(54) **SMART AND ACTIVE ANTENNA ARRAY FOR PORTABLE AND MOBILE TELEVISION RECEPTION**

(75) Inventor: **Oded Bendov**, 226 Walt Whitman Blvd., Cherry Hill, NJ (US) 08003

(73) Assignee: **Oded Bendov**, Cherry Hill, NJ (US)

(*) Notice: Subject to any disclaimer, the term of this patent is extended or adjusted under 35 U.S.C. 154(b) by 627 days.

(21) Appl. No.: **10/893,844**

(22) Filed: **Jul. 19, 2004**

(65) **Prior Publication Data**

US 2005/0041152 A1 Feb. 24, 2005

Related U.S. Application Data

(60) Provisional application No. 60/495,307, filed on Aug. 14, 2003.

(51) **Int. Cl.**
H04N 5/00 (2006.01)

(52) **U.S. Cl.** **348/836**

(58) **Field of Classification Search** 348/836, 348/725, 731; 342/372; 455/25, 32, 434

See application file for complete search history.

(56) **References Cited**

U.S. PATENT DOCUMENTS

4,709,409 A *	11/1987	Ma et al.	455/325
6,229,486 B1 *	5/2001	Krile	343/700 MS
6,282,184 B1 *	8/2001	Lehman et al.	370/342
6,591,100 B1 *	7/2003	Dent	455/434
7,006,040 B2 *	2/2006	Henderson et al.	342/372
7,162,273 B1 *	1/2007	Abramov et al.	455/562.1
2004/0152415 A1 *	8/2004	Anagnos	455/25

* cited by examiner

Primary Examiner—Paulos M. Natnael

(57) **ABSTRACT**

A television receiving apparatus includes a tuner having an input port for image-representative signals, an input port for an external antenna, and an internal or associated external indoor antenna array including at least two electronically integrated antenna-WLNA elements. A processor includes a plurality of RF switches and at least one hybrid, for selectively generating a plurality of signals including sums and differences of signals from said elements. The sums and differences are compared with each other and with the external antenna signal to select the best signal, and that selected best signal is coupled to the input port of the tuner.

11 Claims, 9 Drawing Sheets

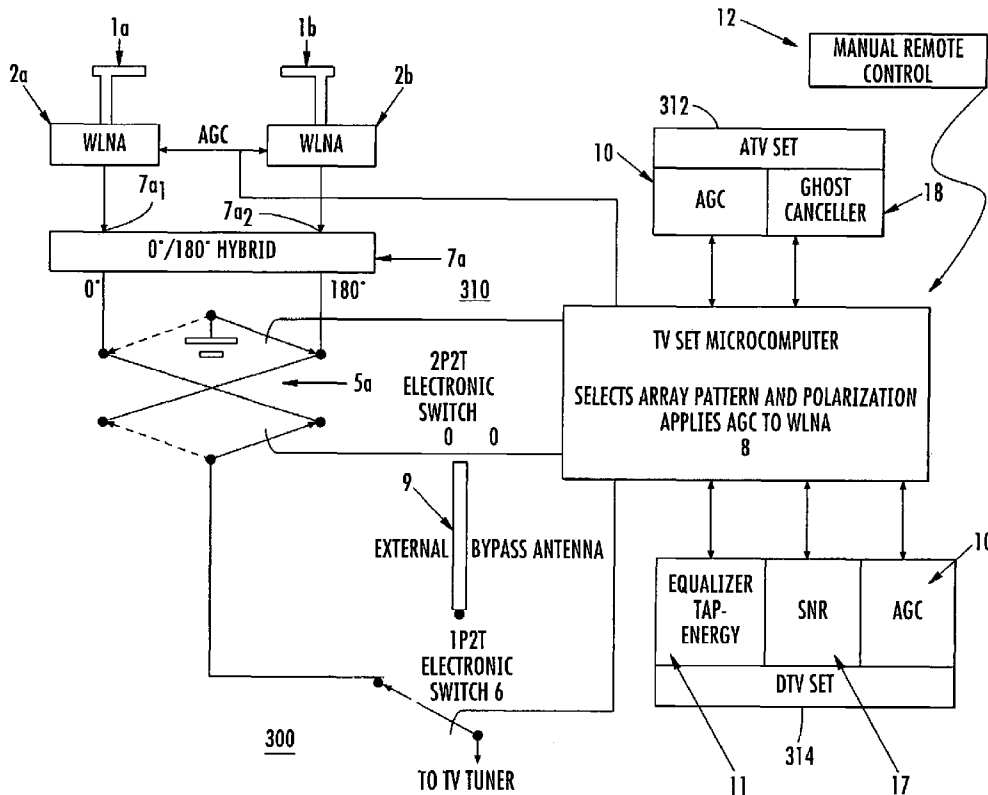

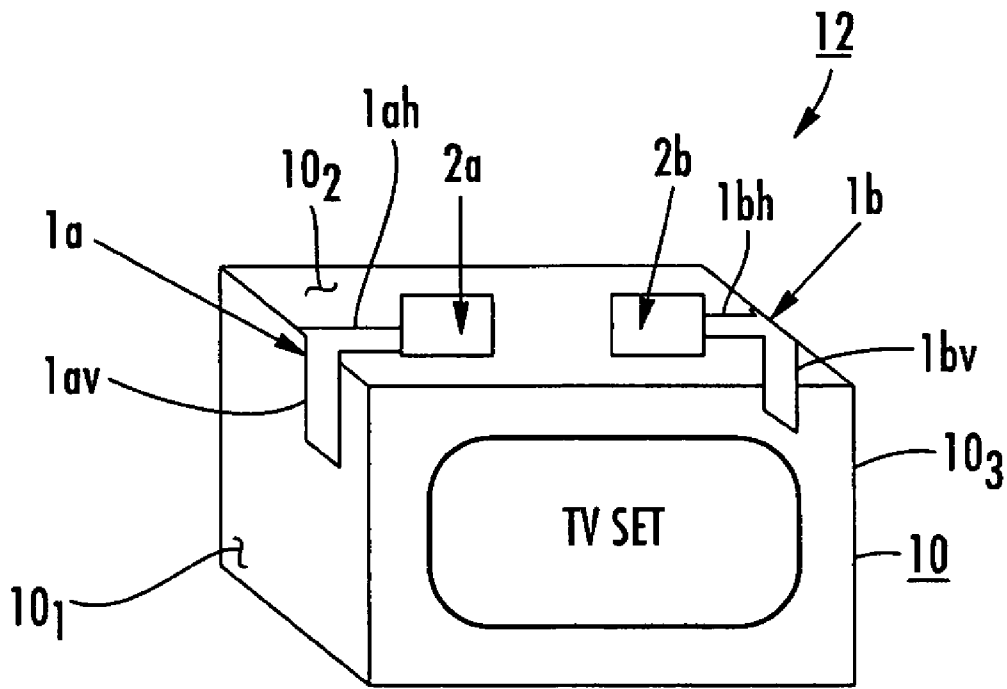

FIG. 1

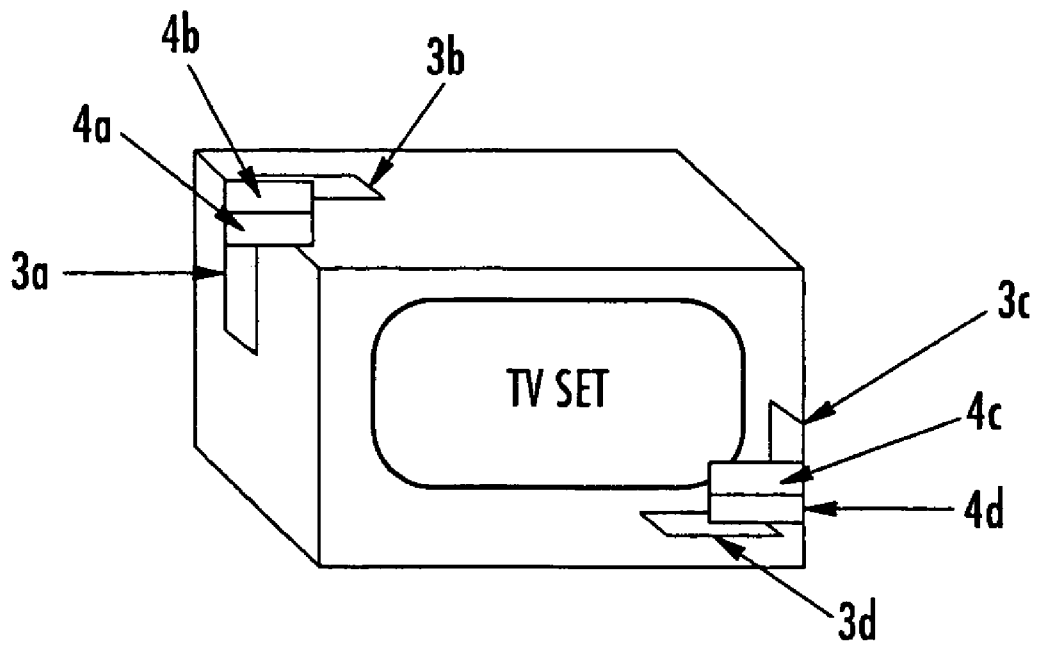

FIG. 2

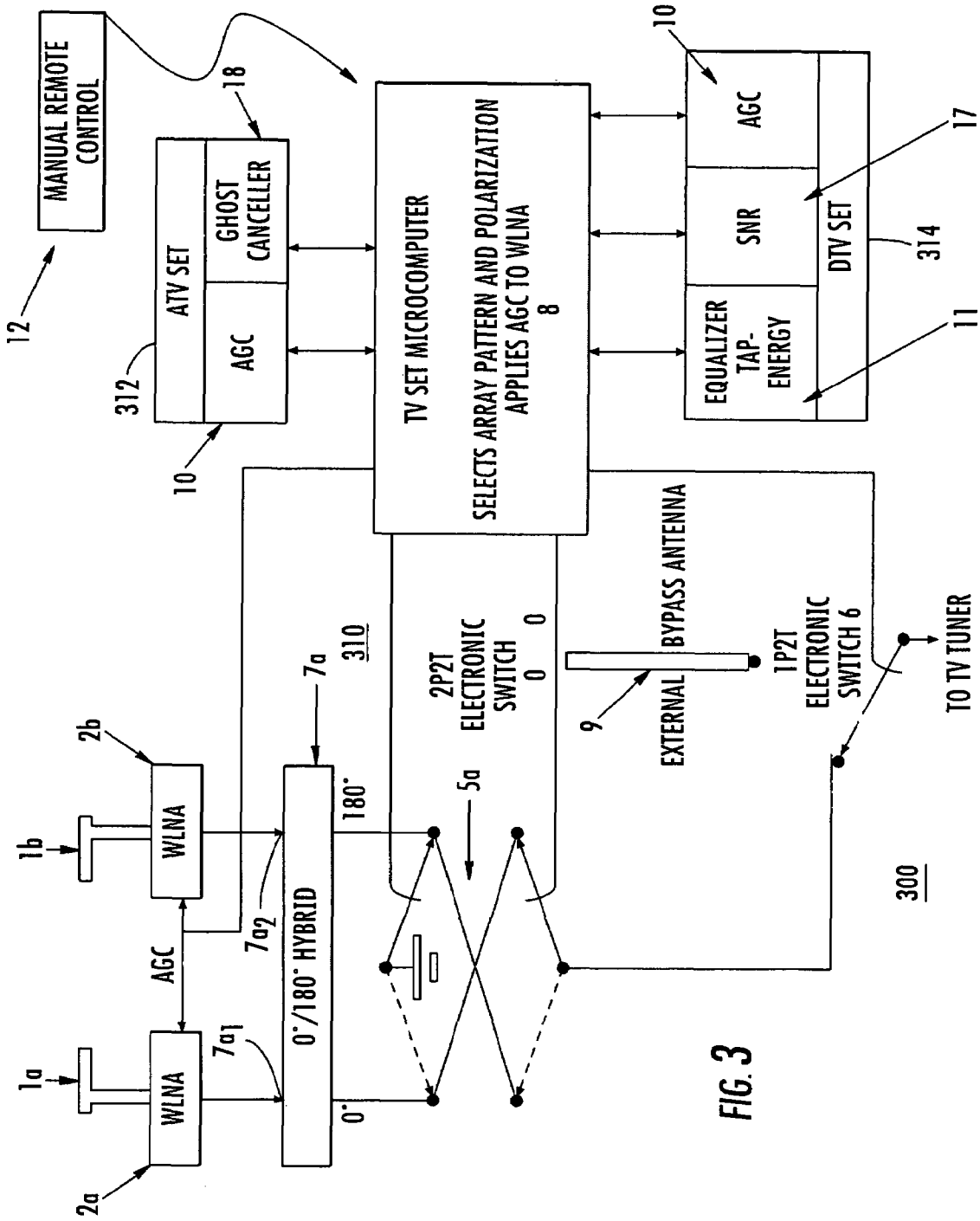

FIG. 3

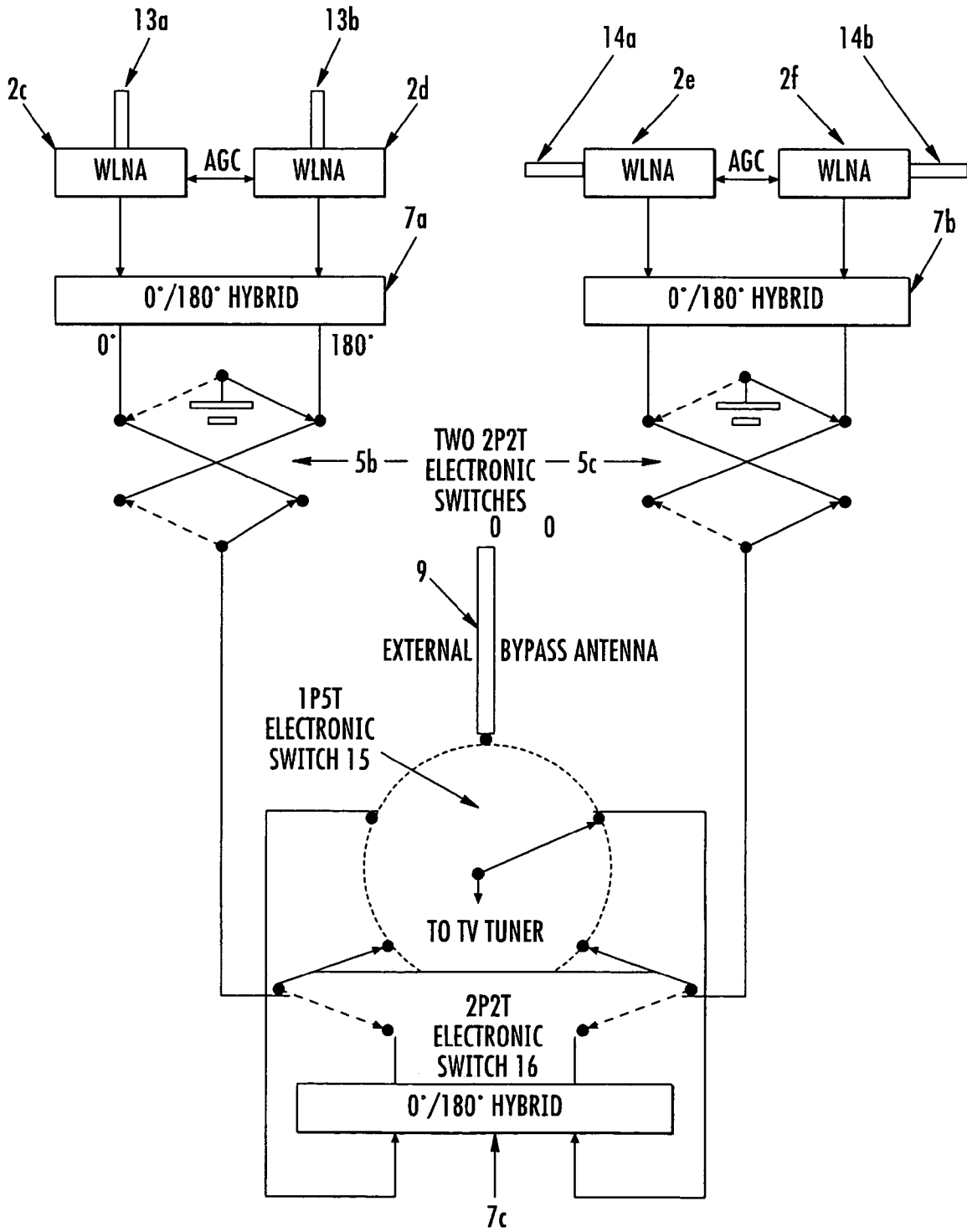
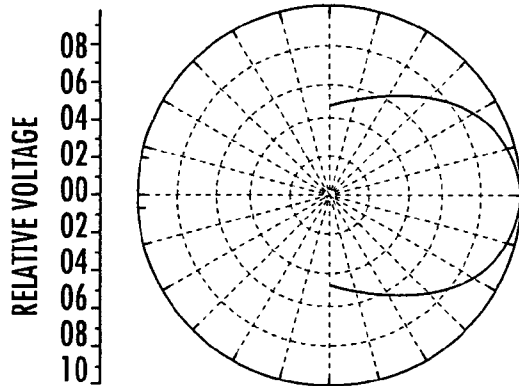
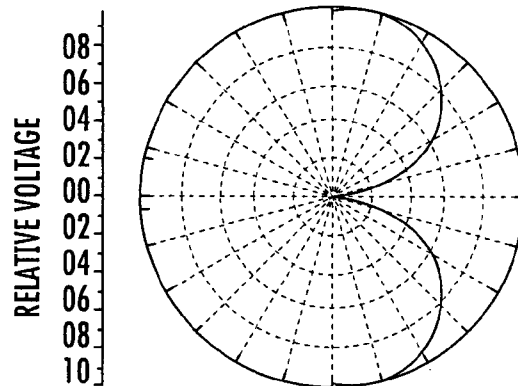

FIG. 4

ELEVATION PATTERNS OF THE HORIZONTAL DIPOLES IN THE SUM (0°) MODE



ELEVATION PATTERNS OF THE HORIZONTAL DIPOLES IN THE DIFFERENCE (180°) MODE



AZIMUTH PATTERNS OF THE VERTICAL DIPOLES IN THE DIFFERENCE (180°) MODE

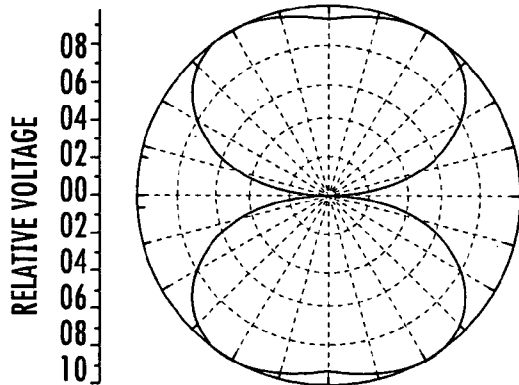

AZIMUTH PATTERNS OF THE VERTICAL DIPOLES IN THE SUM (0°) MODE

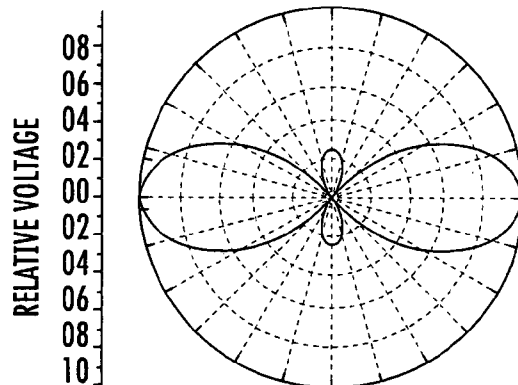
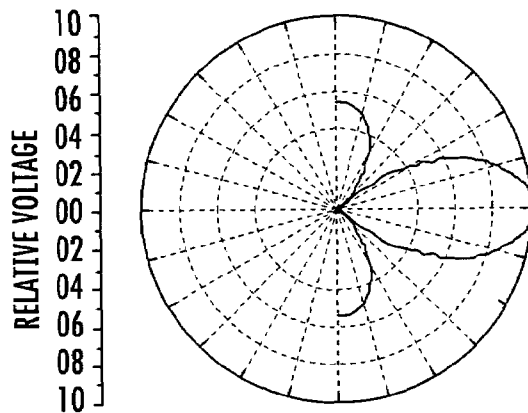
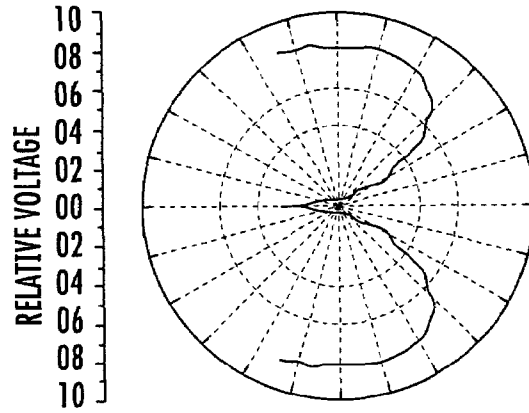

FIG. 5a

ELEVATION PATTERNS OF THE HORIZONTAL DIPOLES IN THE SUM (0°) MODE



ELEVATION PATTERNS OF THE HORIZONTAL DIPOLES IN THE DIFFERENCE (180°) MODE



AZIMUTH PATTERNS OF THE VERTICAL DIPOLES IN THE DIFFERENCE (180°) MODE

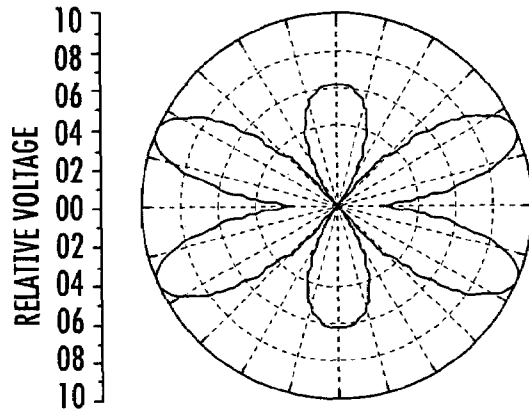

AZIMUTH PATTERNS OF THE VERTICAL DIPOLES IN THE SUM (0°) MODE

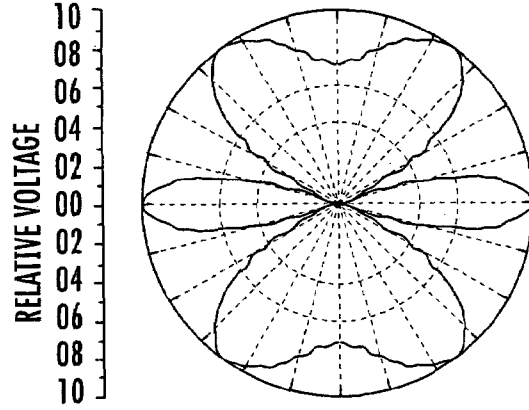
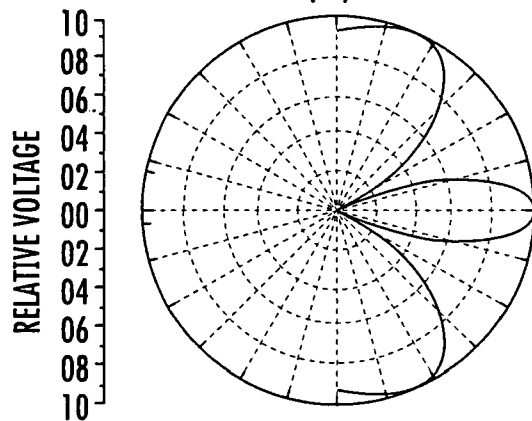
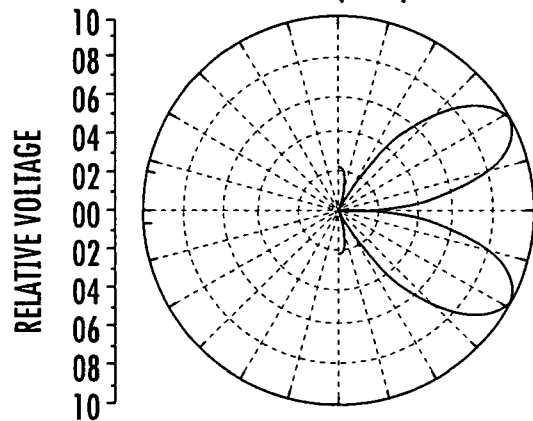

FIG. 5b

ELEVATION PATTERNS OF THE HORIZONTAL DIPOLES IN THE SUM (0°) MODE



ELEVATION PATTERNS OF THE HORIZONTAL DIPOLES IN THE DIFFERENCE (180°) MODE



AZIMUTH PATTERNS OF THE VERTICAL DIPOLES IN THE DIFFERENCE (180°) MODE

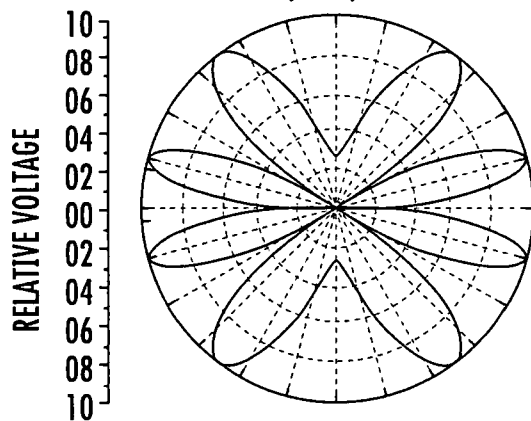

AZIMUTH PATTERNS OF THE VERTICAL DIPOLES IN THE SUM (0°) MODE

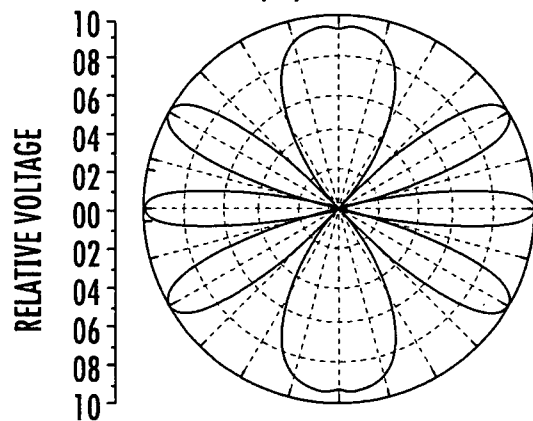
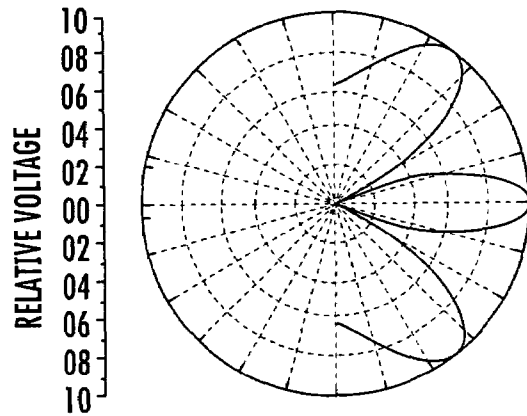
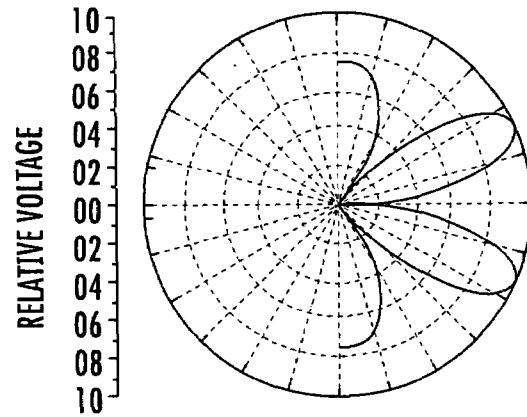

FIG. 5c

ELEVATION PATTERNS OF THE HORIZONTAL DIPOLES IN THE SUM (0°) MODE



ELEVATION PATTERNS OF THE HORIZONTAL DIPOLES IN THE DIFFERENCE (180°) MODE



AZIMUTH PATTERNS OF THE VERTICAL DIPOLES IN THE DIFFERENCE (180°) MODE

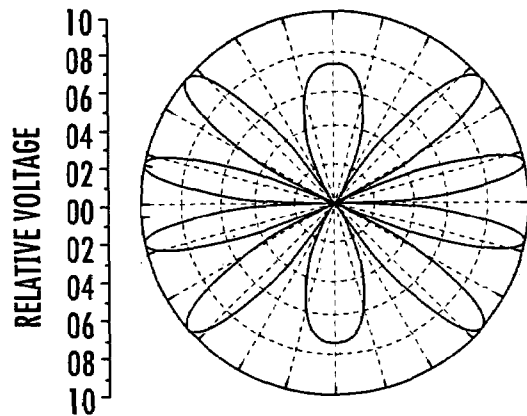

AZIMUTH PATTERNS OF THE VERTICAL DIPOLES IN THE SUM (0°) MODE

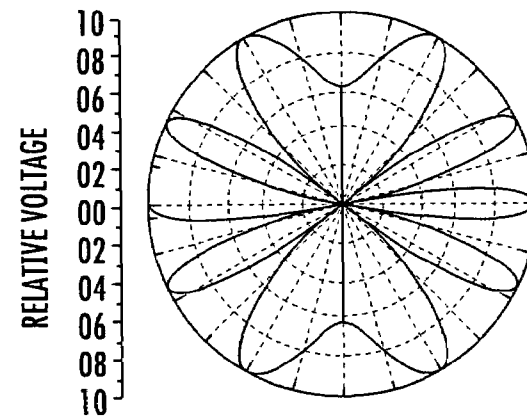

FIG. 5d

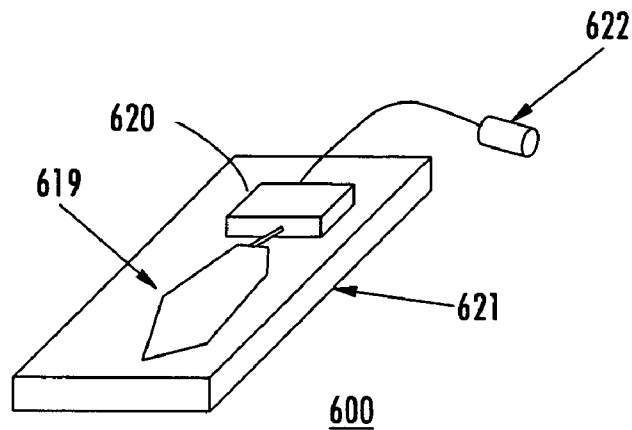

FIG. 6

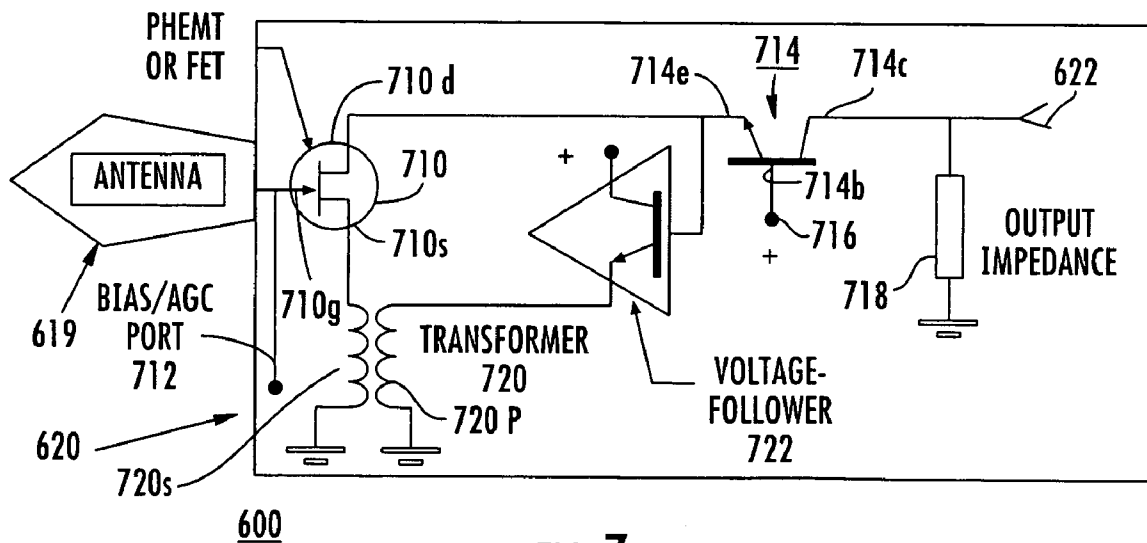

FIG. 7